

Operating instructions

Clean-Break Coupling Low pressure series CT

Nominal bore: 003, 005, 007, 009, 012, 019

optional features:
EX, GG (only CT-019)

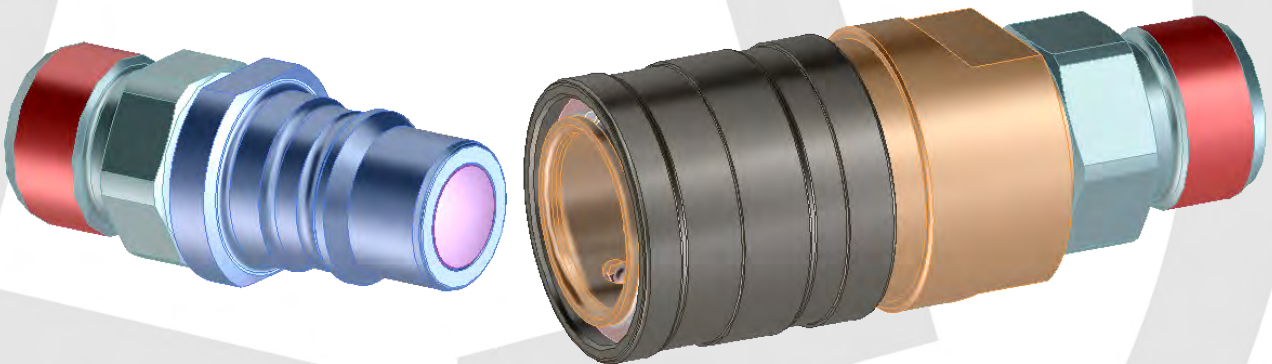

Revision: G

Date: 23.04.2018 • Creator: nh • Approved by: Norbert Heinz

These operating instructions are not subject to change management

The quick coupling system is a quality product that pays particular attention to high functionality, ease of operation, safety, and reliability. As a technical tool, the quick coupling system is designed for use in the commercial and industrial sectors, and by operation by personnel who have received specialist training in the use of technical systems/tools.

Customer service:

Within the scope of our individual customer support, we will be happy to help you with issues regarding use and operation, as well as any problems that may occur.

Service and maintenance:

In order to maintain the high technical performance and reliability of your quick coupling system for several years, we recommend inspection and maintenance on a regular basis. We can optimally support you through our customer service, and offer you the opportunity to conclude a service and maintenance contract. Feel free to request a quote.

Table of contents

1	CE - Conformity	5
1.1	Guideline 2014/68/EU pressure equipment	5
1.2	Directive 2014/34/EU ATEX	5
2	Allgemeines	6
3	Safety instructions	7
3.1	Explain the dangerous- and warning hints	7
3.2	For your safety	7
3.2.1	<i>General information regarding safety precautions</i>	7
3.2.2	<i>Safety precautions</i>	8
3.2.3	<i>Distribution of existing instructions</i>	8
3.2.4	<i>Incorrect selection, improper handling</i>	8
3.2.5	<i>Responsibility of the user</i>	9
3.2.6	<i>Load specifications, torques, framework conditions</i>	9
3.2.7	<i>Other questions</i>	9
3.3	Instructions for the selection of a quick coupling system	10
3.3.1	<i>Specifications and standards</i>	10
3.3.2	<i>Construction size</i>	10
3.3.3	<i>Compatibility of media</i>	10
3.3.4	<i>Media with low inflammability</i>	10
3.3.5	<i>Environment</i>	11
3.3.6	<i>Mechanical loads</i>	11
3.3.7	<i>Pressure</i>	11
3.3.8	<i>Vacuum</i>	12
3.3.9	<i>Coupling or decoupling under pressure</i>	12
3.3.10	<i>Temperature</i>	12
3.3.11	<i>Radiation heat</i>	13
3.4	Correct Installation	13
3.4.1	<i>Examination prior to installation</i>	13
3.4.2	<i>Quick coupling systems or (replacement) parts from other manufacturers</i>	13
3.4.3	<i>Connecting quick couplings systems</i>	13
3.4.4	<i>Heating (e.g. welding and soldering)</i>	14
3.4.5	<i>Connecting electrical components</i>	14
3.4.6	<i>Installation location</i>	14
3.4.7	<i>Protective caps and connectors</i>	14
3.5	Maintenance instructions	15
3.5.1	<i>Maintenance plan</i>	15
3.5.2	<i>Functional testing</i>	15
3.5.3	<i>Replacement intervals</i>	16
4	Warranty	17
4.1	General	17
4.2	Replacement parts	17
5	Product description	18
5.1	Proper use	19
5.2	Technical data	20

5.3	Additional equipment.....	21
5.4	Explosion Protection Directive 2014/34/EU ATEX (Execution EX).....	22
5.4.1	<i>Identification</i>	22
5.4.2	<i>Information on safe operation:</i>	22
5.4.3	<i>Information on safe and proper use:</i>	22
5.4.4	<i>Information on safe installation, disassembly:</i>	23
5.4.5	<i>Information on safe maintenance and servicing:</i>	23
5.4.6	<i>Information on safe installation:</i>	24
5.4.7	<i>Information on hazardous areas:</i>	24
5.4.8	<i>Information on safe applications:</i>	24
5.4.9	<i>Information benchmarks, thresholds:</i>	24
5.4.10	<i>Plans, descriptions, maintenance and operating instructions:</i>	24
5.4.11	<i>EG- Declaration of Conformity / Series Directory</i>	25
6	Installation description.....	26
7	Maintenance and Repair.....	27
7.1	Maintenance.....	27
7.2	Repair.....	28
8	Operating Instruction.....	29
8.1	Coupling Procedure.....	29
8.2	Decoupling Procedure.....	30
9	Test.....	31
9.1	Water bath pearling test for low pressure applications.....	31
9.1.1	<i>Test set-up and procedure of coupled state</i>	31
9.1.2	<i>Test set-up and procedure of decoupled state</i>	32
9.1.3	<i>Test results</i>	32
9.2	Pressure test for medium and high pressure applications.....	33
9.2.1	<i>Test set-up and procedure of coupled state</i>	33
9.2.2	<i>Test set-up and procedure of decoupled state</i>	34
9.2.3	<i>Test results</i>	35
9.3	Documentation.....	35
10	Lubrication.....	36
11	Storage.....	37
12	Decommissioning.....	38
13	Contact data.....	39

1 CE - Conformity

1.1 Guideline 2014/68/EU pressure equipment

According to the guideline 2014/68/EU, classification of pressure equipment, quick couplings are to be assigned to pressure equipment. Generally, quick coupling systems by WALTHER PRÄZISION are designed according to good engineering practice.

For all operating parameters which ensure a classification according to guideline 2014/68/EU and lead to a CE-labelling, the CoC of 2014/68/EU is attached to the product.

1.2 Directive 2014/34/EU ATEX

This quick-coupling system is in principle not designed for operation in non-explosive areas. If this quick-coupling is used in explosive areas, a CE marking is required in accordance with 2014/34/EU. This CE marking is order-related and depends on the conditions for use. A CE declaration of conformity in accordance with Directive 2014/34/EU is enclosed with the product in this case.

2 Allgemeines

These operating instructions contain all the specifications for operating, commissioning and maintaining the quick coupling system.

All specifications and notes in these operating instructions have been compiled taking the applicable specifications, the latest engineering stage of development and our many years of knowledge and experience into account.

The translation of these operating instructions was written to the best of our knowledge. No liability will be assumed for mistranslations. The German version is the original.

The actual scope of delivery may differ from the explanations and graphics described here for special versions or the use of additional ordering options. We reserve the right to make technical changes to the product in the course of improving the performance characteristics and further development. Please contact WALTHER-PRÄZISION if you have any questions.

Unless explicitly mentioned, this series operating manual is not valid for the Y and Z designs of the series described.

	⚠ ATTENTION
	<p>These operating instructions must be read carefully before commencing any work on and with the device, especially prior to commissioning! WALTHER-PRÄZISION assumes no liability for damages and faults caused by non observance of these operating instructions.</p>

WALTHER-PRÄZISION shall assume no liability or warranty for the completeness, correctness and topicality of the information provided in the catalogues / operating instructions / digital media etc. The following applies for all information in the catalogues / operating instructions / digital media etc.: All information is non-binding and subject to changes and errors. The same applies to images.





The operating instructions must be kept directly on the machine and be accessible to all persons working on or with the device. These operating instructions are our property. The transfer of the operating instructions to unauthorised persons is not permitted.

Prior to commissioning, check the device for a faultless condition and proper technical function.

Any replication, evaluation or communication to unauthorised parties is thus actionable and will be pursued in court (copyright law, fair trade law, BGB - German Civil Code). All rights reserved for the event of patent grant (paragraph 7, section 1 German Patent Law) or registration of a utility model or design (paragraph 5, section 4 German Utility Model Law).



3 Safety instructions

3.1 Explain the dangerous- and warning hints

	<p>⚠ DANGER</p> <p>Indicates a danger with high risk. If a warning is not observed, serious injuries or death are the direct consequence.</p>
	<p>⚠ WARNING</p> <p>Indicates a danger with medium risk. If a warning is not observed, serious injuries or death are possible.</p>
	<p>⚠ CAUTION</p> <p>Indicates a danger with low risk. If a warning is not observed, minor to medium severity injuries are possible.</p>
	<p>⚠ ATTENTION</p> <p>Risk or unsafe handling which may cause considerable property or financial damages.</p>
	<p>NOTE</p> <p>Shows information which is concerned either directly or indirectly with the safety of personnel or the protection of the system. If the notification is not observed, faults or property damages are possible.</p>

3.2 For your safety

3.2.1 General information regarding safety precautions

	<p>⚠ ATTENTION</p> <p>This lists instructions for the selection and handling of WALTHER-PRÄZISION quick coupling systems and accessories. These instructions must be applied in conjunction with all other information issued by WALTHER-PRÄZISION pertaining to the relevant products and their accessories. The following instructions must be read and observed prior to the selection and use of a WALTHER-PRÄZISION quick coupling system or the appropriate accessories.</p>
	<p>NOTE</p> <p>WALTHER-PRÄZISION grants a warranty for maintenance/repairs carried out by WALTHER-PRÄZISION or by personnel trained by WALTHER-PRÄZISION. If this work is carried out by a third-party, WALTHER-PRÄZISION accepts no liability for (subsequent) damages.</p>

3.2.2 Safety precautions

	⚠ WARNING
	<p>Quick coupling systems may fail unpredictably for many reasons.</p> <p>Personal injury and/or property damages.</p> <ul style="list-style-type: none"> ▶ For this reason, design all systems and plants in such a way that a failure of the quick coupling system or the relevant supply line will not result in personal injury and/or property damages.

3.2.3 Distribution of existing instructions

	⚠ ATTENTION
	<p>Give a copy of all product-relevant instructions to all persons entrusted with the selection or handling of quick coupling systems. Read the safety precautions and the product-specific publications before selecting and/or using a quick coupling system.</p>

3.2.4 Incorrect selection, improper handling

	⚠ DANGER
	<p>Incorrect selection or improper handling of quick coupling systems and accessories.</p> <p>The consequences are property damage, injuries or death. The following points must be prevented:</p> <ul style="list-style-type: none"> ▶ Uncontrolled flying of the quick coupling systems or other components with high potential risk. ▶ Trapping of body parts caused by reaching between the coupling sides. ▶ Application of electrical voltage in decoupled state. ▶ Leaking of media under high pressure and at high speed. ▶ Impacting, dropping or falling of components caused by a failure of the power unit. ▶ Dangerous lashing out of the connection hose (whip effect). ▶ Explosion or taking fire of the employed media. ▶ Body contact with dangerous media. ▶ Leaking of media that is used in chemical processes. ▶ Technical specifications are not maintained.

3.2.5 Responsibility of the user

	⚠ ATTENTION
	<p>Return of quick coupling systems that are contaminated with a type of media that is a risk to health.</p> <p>Media that is a risk to health is released during the removal process.</p> <ul style="list-style-type: none"> ▶ The quick coupling system must be completely clean when returning it to WALTHER-PRÄZISION. The sender (client) is responsible for ensuring this.

	NOTE
	<p>Due to the different functionalities and the versatility of use of quick coupling systems, WALTHER-PRÄZISION and the associated network of dealers is not able to guarantee that a specific quick coupling system is suitable for each specific end use. These brief instructions do not analyse all of the technical details that are to be taken into consideration in the selection of the quick coupling system. The user is responsible for their own analysis of the following points.</p> <ul style="list-style-type: none"> ▶ For the safe operation and observation of the maintenance and servicing. ▶ The selection of their quick coupling system. ▶ The fulfilment of the requirements of the end user. ▶ The safety precautions which are necessary in order to avoid personal injuries and damage when using quick coupling systems. ▶ Own technical changes.

3.2.6 Load specifications, torques, framework conditions

	⚠ ATTENTION
	<p>Not observed load specifications, torques and other framework conditions.</p> <p>Failure of the quick coupling system.</p> <ul style="list-style-type: none"> ▶ The load specifications, torques and other framework conditions specified by WALTHER-PRÄZISION must be maintained.

	NOTE
	<p>Inquire at WALTHER-PRÄZISION for these load specifications, torques and other framework conditions prior to installation.</p>

3.2.7 Other questions

If you have questions or would like further information, please consult either your supplier or WALTHER-PRÄZISION directly.

3.3 Instructions for the selection of a quick coupling system

3.3.1 Specifications and standards

	NOTE
	<p>When selecting a quick coupling system, country-specific directives, industrial standards and the specifications of WALTHER-PRÄZISION must be taken into account and observed.</p>

3.3.2 Construction size

	⚠ ATTENTION
	<p>Power transfer for incompressible media.</p> <p>Pressure losses and warming or changes in viscosity of the transported media.</p> <ul style="list-style-type: none"> ▶ The power transfer for incompressible media varies according to pressure and flow rates. The construction size of the quick coupling system and other system components must be designed in such a way that pressure losses and warming or changes in viscosity of the transported media are kept as low as possible.

3.3.3 Compatibility of media

	⚠ ATTENTION
	<p>Compatibility between the media and the materials of the quick coupling system.</p> <p>Corrosion, leaks and failure of the quick coupling system</p> <ul style="list-style-type: none"> ▶ Ensure the compatibility between the materials of the components of the quick coupling system and the media used.

	NOTE
	<p>More information regarding compatibility can be found in the seal and material table in your technical catalogue from WALTHER-PRÄZISION.</p>

3.3.4 Media with low inflammability

	NOTE
	<p>Some types of media with low inflammability require a different seal material compared to the material used as standard.</p>

3.3.5 Environment

	⚠ ATTENTION
	<p>Environmental conditions such as UV or radioactive radiation, ozone, mould, water, salt water, air humidity, temperature, chemicals or air contamination.</p> <p>Early wear or failures.</p> <ul style="list-style-type: none"> ▶ Attention should be paid to ensure that the relevant quick coupling system can be stored/used in the relevant environment.

3.3.6 Mechanical loads

	⚠ WARNING
	<p>Unintentional opening or movement of the locking mechanism caused by external forces acting upon it. External forces may include: Pulling the hose over an obstacle, locking mechanism with coarse contours that can be easily moved, or vibrations.</p> <p>Personal injuries caused by failure of the quick coupling system.</p> <ul style="list-style-type: none"> ▶ Quick coupling systems should, for this reason, only be used in the above conditions if a safety lock is present and usage testing has been carried out.

	⚠ ATTENTION
	<p>Unintentional opening or movement of the locking mechanism caused by external forces acting upon it. External forces may include: Pulling the hose over an obstacle, locking mechanism with coarse contours that can be easily moved, or vibrations.</p> <p>Property damages caused by failure of the quick coupling system.</p> <ul style="list-style-type: none"> ▶ Quick coupling systems should, for this reason, only be used in the above conditions if a safety lock is present and usage testing has been carried out.

3.3.7 Pressure

	⚠ DANGER
	<p>The maximum operating pressure of the quick coupling system is exceeded.</p> <p>The consequences are serious injuries or death.</p> <ul style="list-style-type: none"> ▶ The correct selection of the quick coupling system in accordance with the existing operating pressure of the plant.

	⚠ ATTENTION
	<p>The maximum operating pressure of the quick coupling system is exceeded.</p> <p>The consequences are property damages.</p> <ul style="list-style-type: none"> ▶ The correct selection of the quick coupling system in accordance with the existing operating pressure of the plant.

	NOTE
	Do not confuse bursting pressure with operating pressure.

3.3.8 Vacuum

	NOTE
	Not all quick coupling systems can be used for vacuum applications. Quick coupling systems for vacuum applications must be selected in such a way that they do justice to the special operating conditions and pressures.

3.3.9 Coupling or decoupling under pressure

	NOTE
	Decoupling under pressure: Quick coupling systems must in principle be pressure-free when decoupling/decoupled. Unless otherwise indicated, this pressure-free state must be maintained until the system is next coupled.

	⚠ ATTENTION
	The application requires coupling and decoupling under pressure. No proper functionality of the quick coupling system. ▶ Only use quick coupling systems that enable coupling and decoupling under pressure.

	NOTE
	The maximum coupling pressure may be lower than the maximum operating pressure.

3.3.10 Temperature

	⚠ WARNING
	Exceeding or undercutting the permitted temperature values at a standstill or in active operation. Burning or freezing. ▶ For brief handling procedures, use protective gloves. ▶ For longer-lasting contact, observe the appropriate current safety regulations.

3.3.11 Radiation heat

	⚠ WARNING
	<p>Radiation heat acting on quick coupling systems may ruin the sealing material or even the body of the coupling.</p> <p>Personal injury</p> <p>▶ This risk must be taken into account by the user and suitable measures must be taken.</p>

	⚠ ATTENTION
	<p>Radiation heat acting on quick coupling systems may ruin the sealing material or even the body of the coupling.</p> <p>Property damage</p> <p>▶ This risk must be taken into account by the user and suitable measures must be taken.</p>

3.4 Correct Installation

3.4.1 Examination prior to installation

	NOTE
	<p>Prior to installing the quick coupling system, you must check whether the material of the components, the seal material and the reference data match the specifications. Prior to final installation, both sides of the coupling should be coupled and decoupled as a test.</p>

3.4.2 Quick coupling systems or (replacement) parts from other manufacturers

	NOTE
	<p>Use only WALTHER-PRÄZISION original (replacement) parts in order to ensure the operation and maintenance of your quick coupling system. We expressly remind you that we do not offer liability, warranty and service, when (replacement) parts from other manufacturers are used or when combinations are employed which use (replacement) parts from other manufacturers.</p>

3.4.3 Connecting quick couplings systems



	NOTE
	<p>When connecting quick coupling systems, use an appropriate sealant between the cylindrical threads or conical sealing threads. Make sure that the sealant is compatible with the material to be conveyed. Use the provided spanner flats during installation. Always use the correctly sized wrench. Never use pipe tongs or a variable wrench since this will ruin the thread/sealing surfaces in the quick coupling systems and other components of the quick coupling system. Too great a tightening torque may ruin the threads of the quick coupling systems or burst the thread block.</p>

3.4.4 Heating (e.g. welding and soldering)

	⚠ WARNING
	<p>When heating coated components, dangerous gases may be generated which may, among other things, damages seals.</p> <p>Personal injury</p> <ul style="list-style-type: none"> ▶ Use the appropriate guards and wear personal protective equipment when carrying out this task. ▶ Prevent heating of coated components.

	⚠ ATTENTION
	<p>When heating coated components, dangerous gases may be generated which may, among other things, damage seals.</p> <p>Property damage</p> <ul style="list-style-type: none"> ▶ Prevent heating of coated components.

3.4.5 Connecting electrical components

 	⚠ DANGER
	<p>Electrical voltage to components.</p> <p>Serious injuries or death may result from touching components which carry power.</p> <ul style="list-style-type: none"> ▶ Switch off the power supply. ▶ Secure the power supply to prevent it from being switched back on. ▶ Pay attention to the wiring diagram. ▶ Check that no voltage is present.

3.4.6 Installation location

	NOTE
	<p>Install the quick coupling system in such a way that the user is not at risk of slipping, falling, being sprayed, or coming into contact with hot or moving parts.</p>

3.4.7 Protective caps and connectors

	NOTE
	<p>Seal the connections on the coupling sides when they are not required in order to prevent contamination.</p>

3.5 Maintenance instructions

3.5.1 Maintenance plan

	⚠ WARNING
	<p>Failure to carry out maintenance or too large a maintenance gap.</p> <p>Personal injury</p> <ul style="list-style-type: none"> ▶ Observe the contents of the maintenance plan.

	⚠ ATTENTION
	<p>Failure to carry out maintenance or too large a maintenance gap.</p> <p>Property damage</p> <ul style="list-style-type: none"> ▶ Observe the contents of the maintenance plan.

	NOTE
	<p>A maintenance plan must be created and executed by the user. This maintenance plan should contain, at least, the following points, which are to be taken into account and examined in a visual inspection of the quick coupling system.</p> <ul style="list-style-type: none"> ▶ Check for damaged or corroded components of all types. ▶ Leaks from the connection, valve or other components. ▶ Broken coupling mounts (especially for breakaway quick closing devices). ▶ These points require the immediate replacement or repair of the quick coupling system.

	NOTE
	<p>A maintenance plan must be created and executed by the user. This maintenance plan should contain, at least, the following points which are to be taken into account in a visual inspection of the plant.</p> <ul style="list-style-type: none"> ▶ Contamination of the exterior or the connection zone of the quick coupling system. ▶ Other mounts. ▶ Protective mechanisms. ▶ Fluid level, fluid characteristics and ventilation of the system. ▶ Tension relief ▶ Bending radii.

3.5.2 Functional testing

	NOTE
	<p>Please put the system under working pressure. Check the quick coupling system for potential faults and leaks. Check the switches and initiators of safety mechanisms.</p>

**NOTE**

After functional testing, carry out a test phase prior to actual operation. The operating personnel should be protected by the appropriate personal protective equipment as they work on the test phase.

3.5.3 Replacement intervals

**NOTE**

The special replacement intervals must be adapted to correspond to values related to experience, country-specific directives and industrial standards. They also depend on operating safety, standstill times and failure risks.

4 Warranty

4.1 General

The warranty is in accordance with:

the “General terms and conditions for delivery and service” of the company WALTHER-PRÄZISION, in the version valid at the time the purchase contract came into force.

Generally excluded from the warranty are consumables.

Typical wear parts of WALTHER-PRÄZISION products include:

- Seals
- Springs
- Electrical plugged contacts
- Electrical cables and hoses which are subject to regular alternating bending or torsional stresses.

Components that are not normally subject to wear under the conditions to the expected (environmental and usage) may become consumables. This is the case if the described product is not operated according to the intended purpose or is operated with a disregard for the specifications in the operating instructions.

Unless expressly agreed with WALTHER-PRÄZISION, wear caused by exceptional environmental conditions is not covered by the warranty.

Examples of unusual environmental conditions are high temperatures, dust with an abrasive effect, high humidity, and corrosive vapours and gases.

Cycle, time or load dependant specifications within the maintenance framework are used as preventive maintenance measures, with which to avoid standstill times during production. This information does not constitute a guarantee-relevant life expectancy statement.

4.2 Replacement parts



NOTE

Use only WALTHER-PRÄZISION original (replacement) parts in order to ensure the operation and maintenance of your quick coupling system. We expressly remind you that we do not offer liability, warranty and service, when (replacement) parts from other manufacturers are used or when combinations are employed which use (replacement) parts from other manufacturers.

5 Product description

The quick coupling system is made up of:

Clean Break coupling	1-CT-003-0-.....-....
Clean Break adaptor	1-CT-003-2-.....-....
Clean Break coupling	1-CT-005-0-.....-....
Clean Break adaptor	1-CT-005-2-.....-....
Clean Break coupling	1-CT-007-0-.....-....
Clean Break adaptor	1-CT-007-2-.....-....
Clean Break coupling	1-CT-009-0-.....-....
Clean Break adaptor	1-CT-009-2-.....-....
Clean Break coupling	1-CT-012-0-.....-....
Clean Break adaptor	1-CT-012-2-.....-....
Clean Break coupling	1-CT-019-0-.....-....
Clean Break adaptor	1-CT-019-2-.....-....

Unless both halves of the quick coupling system are not connected, they should be protected against external contamination and damage.

For this purpose, dust caps and dust plugs are available for the following nominal sizes.

Clean Break coupling	1-CT-005-0-.....-.... with
Dust cap	1-SK-028-9-17325-AAAA-T015
Clean Break adaptor	1-CT-005-2-.....-....
Dust cap	1-SL-014-9-17325-AAAA-T022
Clean Break coupling	1-CT-007-0-.....-.... with
Dust cap	1-SK-033-9-22328-AAAA-T017
Clean Break adaptor	1-CT-007-2-.....-....
Dust cap	1-SL-018-9-17325-AAAA-T028
Clean Break coupling	1-CT-009-0-.....-.... with
Dust cap	1-SK-036-9-24430-AAAA-T017
Clean Break adaptor	1-CT-009-2-.....-....
Dust cap	1-SL-020-9-24430-AAAA-T030
Clean Break coupling	1-CT-012-0-.....-.... with
Dust cap	1-SK-040-9-35442-AAAA-T017
Clean Break adaptor	1-CT-012-2-.....-....
Dust cap	1-SL-022-9-35442-AAAA-T030
Clean Break coupling	1-CT-019-0-.....-.... with
Dust cap	1-SK-058-9-47455-AAAA-T020
Clean Break adaptor	1-CT-019-2-.....-....
Dust cap	1-SL-035-9-44450-AAAA-T046

Possible parking stations and pressure-tight dust caps

NW 3	1-CT-003-6-00002-N2 parking station 1-CT-003-5-N2-. pressure-tight dust cap
NW 5	1-CT-005-6-00002-N2 parking station 1-CT-005-5-N2-. pressure-tight dust cap
NW 7	1-CT-007-6-00002-N2 parking station 1-CT-007-5-N2-. pressure-tight dust cap
NW 9	1-CT-009-6-00002-N2 parking station 1-CT-009-5-N2-. pressure-tight dust cap
NW 12	1-CT-012-6-00002-N2 parking station 1-CT-012-5-N2-. pressure-tight dust cap
NW 19	1-CT-019-6-00002-N2 parking station 1-CT-019-5-N2-. pressure-tight dust cap

Recommendation:

To protect the sealing surfaces, the self-sealing adaptors shall be mounted tightly and the self-sealing couplings shall be used as free half.

5.1 Proper use

- The CT series quick coupling series is a latest generation plug coupling for the low pressure range (up to 64 bar / 928 psi).
- The quick coupling system is used only for the connection of two lines.
- The coupling and decoupling procedure is a manual one.
- The quick coupling system has an automatic lock, i.e. one-handed operation is possible.
- Coupling and decoupling is splash-free.
- The quick coupling system is suitable for all applications requiring the lowest leakages, the simplest operation and high throughflow.
- For all other possible uses consult WALTHER-PRÄZISION.

5.2 Technical data

	⚠ ATTENTION
	<p>When defining the operating pressures for standardised thread connections, the maximum permissible operating pressure of the connection must be taken into account.</p>

	⚠ ATTENTION
	<p>Depending on the material property or connection, different higher or lower operating pressures are possible. This operating pressure can be found in the project documents.</p>

	Maximum operating pressure without taking into account the connections stainless steel coupled bar / psi	Maximum operating pressure without taking into account the connections stainless steel decoupled bar / psi	The coupling is possible up to the following residual pressure bar / psi
CT-003	64 / 928	30 / 435	30 / 450
CT-005	64 / 928	30 / 435	25 / 362
CT-007	64 / 928	30 / 435	10 / 145
CT-009	64 / 928	30 / 435	10 / 145
CT-012	64 / 928	30 / 435	8 / 116
CT-019	40 / 580	30 / 435	2 / 29

	leakage quantity(ml) at 3,5 bar at 50 psi	Cv value
CT-003	0,03	0,45
CT-005	0,1	0,8
CT-007	0,1	1,85
CT-009	0,1	2,75
CT-012	0,15	4,5
CT-019	0,3	9,8

Temperature

The permitted operating temperature lies between +5 °C and +70 °C.

Deviating operating temperatures are generally project-related.

- When decoupled, both sides of the quick coupling system must be protected against external contamination.
- The quick coupling system may only be used in accordance with the intended purpose.
- The technical specifications must be adhered to.
- WALTHER-PRÄZISION is not responsible for any personal injuries or property damages caused as a result of incorrect use and of ignoring the technical specifications.

5.3 Additional equipment

GG = with ring reef (cast aluminium)
only **CT-019** (e.g.: 1-CT-019-0-.....-.....-GG)



symbolic representation

EX = ATEX - Version

5.4 Explosion Protection Directive 2014/34/EU ATEX (Execution EX)

5.4.1 Identification

The quick coupling systems must be written as follows:

1. WALTHER-PRÄZISION
Carl Kurt Walther GmbH &Co.KG
Westfalenstrasse 2
42781 Haan
2. Typ (according to the serial list)

For the category 2G

CE 1637  II 2G IIC T X

For the category 2D

CE 1637  II 2D c T150°C X

The temperature class is defined by the operator on the basis of the fluid temperature, whereby the EN 13463 - 1 safety temperature distances must be observed.

5.4.2 Information on safe operation:

- When using the quick coupling system as hose connections, it is necessary to ensure that, in case of pressure surges, the quick coupling system is prevented from being knocked over by fastening it to suitable supports.
It is important to ensure that the quick coupling system is not knocked by hard objects that may cause a spark when touching the housing.
- It's important to ensure that the seals are resistant to the flowing media.

5.4.3 Information on safe and proper use:

- The quick coupling systems are intended for connecting hoses or pipelines.
- The operator should prevent flames and hot gases coming near to or making contact with the quick coupling system.
- Letter X for category 2G:
Definition of temperature class taking into account a safety distance as a function of the fluid temperature.

Max. Fluid temperature	Temperature class
75	T6
90	T5
130	T4
195	T3
295	T2
445	T1

- Letter X for category 2D:
The maximum fluid temperature must not exceed 140 °C.
- Flammable dust in those areas where the quick coupling systems are installed and operated must have an ignition temperature of more than 150 °C.
The ignition temperature shall be determined in accordance with IEC 61241-2-1.
(Dust in deposited form - according to procedure A,

Dust in fluidized form - according to procedure B).

- The quick coupling system must not be used in areas where there are hybrid mixtures of flammable gases and combustible dusts.

5.4.4 Information on safe installation, disassembly:

- Before assembly or disassembly, the hoses and lines must be depressurised.
- Pipes or hoses must be used for the connections of the quick coupling systems, which have an electrostatic, dissipative connection to ground potential.
- The protective caps have a connection to the ground potential (conductive connection of the fine cables or chains to the quick coupling system parts VK and VN).
- If it is necessary to use proximity switches to monitor the quick coupling systems, only explosion-proof proximity switches and the associated isolating switching amplifiers approved by WALTHER-PRÄZISION may be used.

5.4.5 Information on safe maintenance and servicing:

- The quick coupling systems must be cleaned at regular intervals.
- Only the original spare parts approved by WALTHER-PRÄZISION may be used. This also applies to the protective caps and their fasteners.
- The conductive connection of the quick coupling systems, hoses and pipes to the ground potential must be checked by the operator at regular intervals.
- The operator must regularly maintain and check the protection of the quick coupling system from exposure to direct lightning strikes (e.g. lightning protection system).
- The fastening elements of the protective caps made of fine ropes or chains may have a maximum length of 500 mm.
- The fasteners made of fine ropes or chains must be checked by the operator on a regular basis, according to the operating conditions, to the proper condition and to a tight fit.
- The operator has to check the effectiveness of the connection of the coupling parts and the protective caps to the equipotential bonding in appropriate conditions according to the operating conditions..

5.4.6 Information on safe installation:

- The operating instructions must be observed during installation and operation.
- The quick coupling system must be protected against direct lightning strikes by appropriate means (e.g. lightning protection equipment).
- The quick coupling system may only be operated in, areas with good, external ventilated.
- The quick coupling system parts must be secured from falling.
- The Halves of the quick couplings systems, which are not “splash-free” due to their design when coupling and uncoupling, must only be coupled and uncoupled without pressure (see series list).

5.4.7 Information on hazardous areas:

- When applying flammable liquids to the (inside of the) quick coupling system, occasional minor leaks may occur during uncoupling.
As a result, an explosive atmosphere can form around the contour of the quick coupling system at a distance of approx. 50 cm.

5.4.8 Information on safe applications:

- According to equipment categories 2G and 2D, the quick coupling systems may only be used in potentially explosive atmospheres in which explosive gas, steam, mist, air mixtures and dust and air mixtures are present **occasionally**.

5.4.9 Information benchmarks, thresholds:

- The permissible ambient and fluid temperatures as well as the internal pressure are determined by the sealing material and can be found in the operating instructions.

5.4.10 Plans, descriptions, maintenance and operating instructions:

are included

5.4.11 EG- Declaration of Conformity / Series Directory

Types / Series	Limits / Features	Squirt-free
04-005	—	
20-019	Maximum drop height of the quick coupling system in tear-off fall is 1,80 m. Maximum weight of the quick coupling system, including the associated coupling hose or pipe connection: 28 kg. Operating pressure: max. 7 bar	X
33	—	
BF	The lever of the quick coupling system from the BF series must not be abruptly operated to prevent sparks or adiabatic shock waves. The manual drive of the quick coupling system from the BF series must have an electrostatically conductive connection to the housing.	X
CN	—	X
CT	—	X
CP	—	X
DD	—	X
HP	—	
LP	—	
MD	—	
SP	—	
UF	—	
Multi coupling 91583 with the elements CD-010, CD-025, CD-050, MD-012, MD-019	When connecting the free plate with the fixed plate and when inserting the adaptor into the coupling, the coupling speed must be <1 m/s. The swing bolts must not abruptly fall and strike the quick coupling system or other structural parts. The guiding of the swing bolts into the fixed plate is supported with flats of fluorocarbon rubber so that the friction between the swing bolts and the loose part plate is increased in such a way that falling of the swing bolts is eliminated. This function must be regularly checked by the operator. The swing bolts are used for static and dynamic operating pressure and resultant forces. This must be regularly monitored by the operator. The free part and fixed part must each have an electrostatic discharging connection to earth potential (each free plate and fixed plate separately).	

6 Installation description

The quick coupling system is to be installed in a pipeline network under the observation of the general accident prevention regulation in such a way that

- correct operation in accordance with the operating instructions is guaranteed. This includes the fact that during assembly or disassembly both halves of the quick coupling system on the customer structure, only the hexagon is used on the customer connection for tightening or releasing.

"Exemplary diagram showing correct assembly/disassembly"



"Exemplary diagram showing incorrect assembly/disassembly"



- The screw fitting on the customer connection side must follow the current technical rules.
- external damage to the quick coupling system and all moving parts is excluded.
- the coupling is used primarily on the grid side and the adaptor primarily on the consumer side.

	<p>NOTE</p> <p>Before both halves of the quick coupling system are installed in a pipeline network, it must be ensured that the pipeline network has been rinsed/blown out or cleaned sufficiently.</p>
---	--

	<p>NOTE</p> <p>After completing the installation, a leak test of the connections must be carried out.</p>
---	--

7 Maintenance and Repair

Use the quick coupling systems of WALTHER-PRÄZISION in such a way as to exclude damages.

	NOTE
	<p>WALTHER-PRÄZISION grants a warranty for maintenance/repairs carried out by WALTHER-PRÄZISION or by personnel trained by WALTHER-PRÄZISION. If this work is carried out by a third-party, WALTHER-PRÄZISION accepts no liability for (subsequent) damages.</p>

	⚠ ATTENTION
	<p>Return of quick coupling systems that are contaminated with a type of media that is a risk to health.</p> <p>Media that is a risk to health is released during the removal process.</p> <ul style="list-style-type: none"> ▶ The quick coupling system must be completely clean when returning it to WALTHER-PRÄZISION. The sender (client) is responsible for ensuring this.

7.1 Maintenance

	NOTE
	<p>A maintenance plan must be created and executed by the user. This maintenance plan should contain, at least, the following points, which are to be taken into account and examined in a visual inspection of the quick coupling system.</p> <ul style="list-style-type: none"> ▶ Check for damaged or corroded components of all types. ▶ Leaks from the connection, valve or other components. ▶ Broken coupling mounts (especially for breakaway quick closing devices). ▶ These points require the immediate replacement or repair of the quick coupling system.

	NOTE
	<p>A maintenance plan must be created and executed by the user. This maintenance plan should contain, at least, the following points which are to be taken into account in a visual inspection of the plant.</p> <ul style="list-style-type: none"> ▶ Contamination of the exterior or the connection zone of the quick coupling system. ▶ Other mounts. ▶ Protective mechanisms. ▶ Fluid level, fluid characteristics and ventilation of the system. ▶ Tension relief ▶ Bending radii.

In order to minimise activation forces and to extend the lifetime of the quick coupling system, we recommend lightly greasing the connecting surfaces if this is permitted.

Check all connections for secure connection.

As described under the section called Operating instructions, the quick coupling system is coupled several times, pressure is applied and then it is decoupled.

The coupling and decoupling procedure may only be carried out under the observation of safety instructions and intended use.

The quick coupling system must function perfectly and smoothly and be sealed when coupled and decoupled.

Repairs must be made when faults are determined.

	NOTE
	When repairing, a pressure and sealing test must always be carried out. This may also be completed by means of the working process. The procedure and scope of this test is described in the "Testing" section.

7.2 Repair

	NOTE
	In the event of damaged, cracked or corroded parts, the quick coupling system must be removed and sent to WALTHER-PRÄZISION for repair.

	NOTE
	In the event of worn, brittle or overaged seals as well as serious contamination, it is the decision of the customer whether they wish to send the quick coupling system to WALTHER-PRÄZISION or whether they wish to repair it themselves.

8 Operating Instruction

In order to avoid potentially life-threatening injuries to personnel and damages to the quick coupling system during operation, this may only be used for its intended purpose.

The coupling and decoupling procedure may only be carried out under the observation of safety instructions and intended use.

Coupling is pressure-free or with minimal residual pressure. Actuation is primarily defined by the forces applied by hand.

These in turn depend on the installation location (e.g. overhead) of the fitting.

If manual actuation is not possible when coupling or decoupling, it is recommended to consult WALTHER-PRÄZISION.

symbolic representation

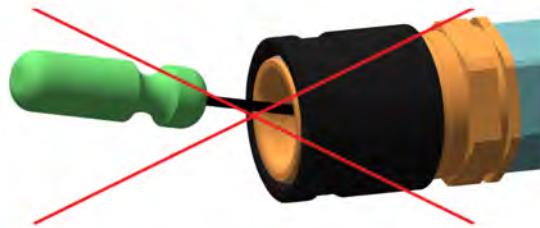

Valves of all kinds may not be opened using force.

8.1 Coupling Procedure

Prior to each coupling process, carry out a visual inspection of the quick coupling system. Damaged parts are to be replaced in accordance with maintenance and repair.

The quick coupling system has an automatic lock, i.e. one-handed operation is possible.

	⚠ ATTENTION
	<p>The locking sleeve moves backwards and then forwards again when coupling.</p> <p>Fingers may become trapped.</p> <p>▶ Do not hold the coupling or nipple directly in the range of motion of the locking sleeve.</p>

Hold the coupling behind the locking sleeve or the nipple in the range of the connection element with one hand and push the counterpart axially and centrally, as far as it will go onto the fixed side.

The locking sleeve automatically locks forward, whilst the coupling and nipple are locked mechanically.

Open existing valves when coupling. This ensures the throughflow.

	⚠ ATTENTION
	<p>After coupling, the locking sleeve must be in the end position, i.e. sealed at the front flush with the coupling housing.</p> <p>Otherwise proper locking cannot be assured.</p>

symbolic representation

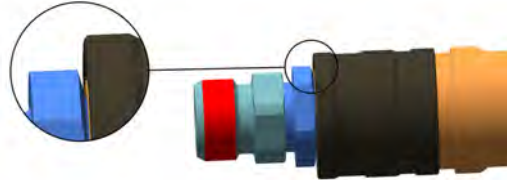

8.2 Decoupling Procedure

Pull back the locking sleeve against the lock spring and separate the coupling and nipple.

After separating the connection, the locking sleeve slips into its initial position for re-coupling. This position is the same in both the coupled and decoupled state.

Existing valves close automatically on decoupling meaning that no further media leakage is possible.

	⚠ ATTENTION
	<p>If pressure exists in the lines connected by the quick coupling system when separating them, a strong separation force can occur on the quick coupling system depending on the pressure.</p> <p>The consequences can be property damage and injuries.</p> <p>▶ The quick coupling system must be held firmly in the hand.</p>

9 Test

For applications of up to 2 bar, WALTHER-PRÄZISION recommends a tightness test in the form of a water bath bead test. For applications exceeding 2 bar, it is down to the user to decide whether a tightness test in the form of a water bath bead test, or a pressure test using the testing equipment should be carried out.

9.1 Water bath pearling test for low pressure applications

9.1.1 Test set-up and procedure of coupled state

Test set up in the coupled state (diagram)

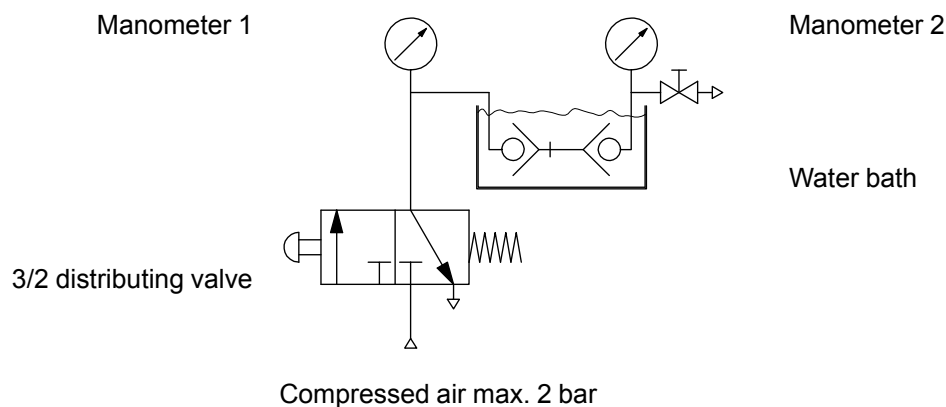

Test sequence

- Set up the test equipment
- The 3/2-way valve is activated by the button, and held during the entire test.
- The air pressure of the fittings must be max. 2 bar; the manometer indicates the pressure present.
- The holding time per test is 10 seconds.
- To end the test, release the buttons on the 3/2-way valve. The 3/2-way valve returns to the initial position due to the spring preload.
- The medium (compressed air) in the test equipment escapes into the environment through the 3/2-way valve.
Both manometers must show **0 bar**.

	⚠ WARNING
	<p>Both manometers show 0 bar.</p> <p>The test has not been carried out correctly. It may NOT be uncoupled.</p> <p>► By opening the shut-off valve on manometer 2, the remaining pressure can be released.</p>

- If both pressure gauges show 0 bar, they can be uncoupled, and the test equipment can be dismantled.
- After successfully carrying out the troubleshooting, the test must be repeated correctly.
- The test equipment can be dismantled.
- After the test, the fitting must be dried as quickly as possible in warm air

(Recommended: 45 - 5°C, approx. 30 min in the case of air flow, up to 2 h in the case of stationary air, depending on the device).

9.1.2 Test set-up and procedure of decoupled state

The test set-up and procedure are the same for the coupling and nipple.

Test set up in the uncoupled state (diagram)

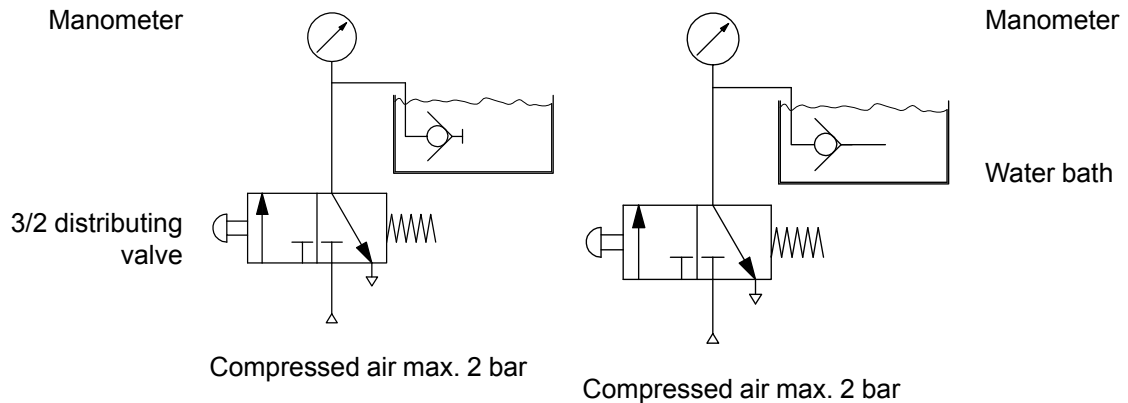

Test sequence

- Set up the test equipment
- The 3/2-way valve is activated by the button, and held during the entire test.
- The air pressure of the fittings must be max. 2 bar; the manometer indicates the pressure present.
- The holding time per test is 10 seconds.
- To end the test, release the buttons on the 3/2-way valve. The 3/2-way valve returns to the initial position due to the spring preload.
- The medium (compressed air) in the test equipment escapes into the environment through the 3/2-way valve.
The manometer will be reset to **0 bar** when the test equipment is set up correctly.
- The test equipment can be dismantled.
- After the test, the fitting must be dried as quickly as possible in warm air
(Recommended: 45 - 5°C, approx. 30 min in the case of air flow, up to 2 h in the case of stationary air, depending on the device).

9.1.3 Test results

There must be no blistering during the 10 second hold time, either when coupled or uncoupled. If blistering occurs in these 10 seconds, the fittings are leaky and should not be used. The error must be located and corrected, and the test must be repeated.

9.2 Pressure test for medium and high pressure applications

9.2.1 Test set-up and procedure of coupled state

Test set up in the coupled state (diagram)

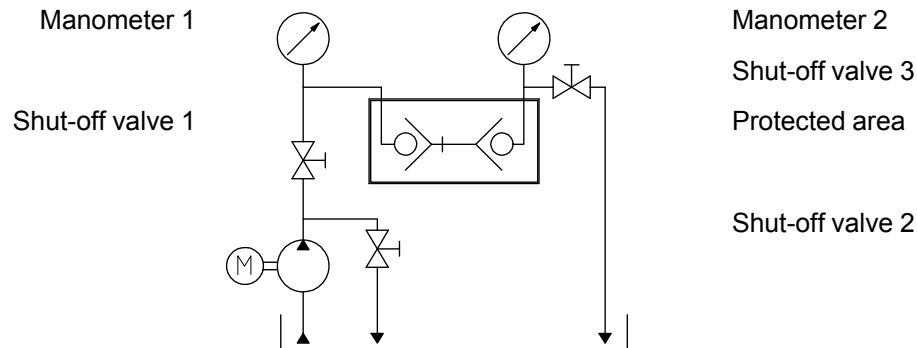

Test sequence

- Set up the test equipment
- The test equipment and its individual components must comply with relevant safety regulations, e.g. operational safety ordinances, etc., and be designed for the required pressure.
The container (protected area) in which the valve is located during the test must be designed in such a way that neither the pressurised medium nor pieces of the test equipment can put the operator at risk (e.g. by bursting).
- The test medium is water or oil, depending on the material of the fitting to be tested. The sealing material EPDM may **not** be tested with oil.
- The operator of the test equipment is under the obligation to plan measures to ensure proper operation and check the implementation.
- At the start of the test, shut-off valve 1 is open; shut-off valves 2 and 3 are closed.
- During the pressure test, it must be ensured that no gaseous (and therefore compressible) media remain in the fitting.
- For this purpose, the fitting must be vented before pressurisation.
Because of this, shut-off valves 1 and 3 are opened and the test medium is passed through the test specimen until no gaseous medium is present.
- Stop the pump and close shut-off valve 3.
- Slowly apply the test pressure to the fitting. The test pressure is 1.3 x the operating pressure (see product description for operating pressure).
- Both manometers show the test pressure.
- Close shut-off valve 1; the test pressure will now remain in the valve for a period of 5 minutes.
- Switch off the pump and open shut-off valve 2.
- To end the test, open shut-off valve 1; the test medium will flow back into the tank.
- Both manometers must show **0 bar**.

	⚠ WARNING
	<p>Both manometers show 0 bar.</p> <p>The test has not been carried out correctly. It may NOT be uncoupled.</p> <p>▶ By opening the shut-off valve on manometer 3, the remaining pressure can be released.</p>

- If both pressure gauges show **0 bar**, they can be uncoupled, and the test equipment can be dismantled.
- After successfully carrying out the troubleshooting, the test must be repeated correctly.
- After the test, the fitting must be dried as quickly as possible in warm air (Recommended: 45 - 5°C, approx. 30 min in the case of air flow, up to 2 h in the case of stationary air, depending on the device).

9.2.2 Test set-up and procedure of decoupled state

The test set-up and procedure are the same for the coupling and nipple.

Test set up in the uncoupled state (diagram)

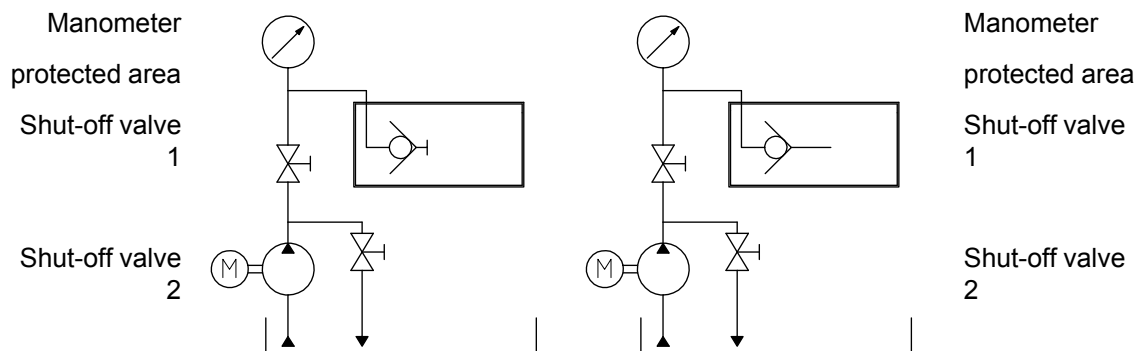

Test sequence

- Set up the test equipment
- The test equipment and its individual components must comply with relevant safety regulations, e.g. operational safety ordinances, etc., and be designed for the required pressure.
The container (protected area) in which the valve is located during the test must be designed in such a way that neither the pressurised medium nor pieces of the test equipment can put the operator at risk (e.g. by bursting).
- The test medium is water or oil, depending on the material of the fitting to be tested. The sealing material EPDM may **not** be tested with oil.
- The operator of the test equipment is under the obligation to plan measures to ensure proper operation and check the implementation.
- During the pressure test, it must be ensured that no gaseous (and therefore compressible) media remain in the fitting.
- The fitting must be vented before pressurisation.
Because of this, shut-off valves 1 and 3 are opened and the test medium is passed through the test specimen until no gaseous medium is present.

- Turn off the pump, uncouple the unit, and slowly apply the test pressure to the relevant side (coupling or nipple) in the uncoupled state. The test pressure is 1.3 x the operating pressure (see product description for operating pressure).
- The manometer shows the test pressure.
- Close shut-off valve 1; the test pressure will now remain in the valve for a period of 5 minutes.
- Switch off the pump and open shut-off valve 2.
- To end the test, open shut-off valve 1; the test medium will flow back into the tank. The manometer will be reset to **0 bar** when the test equipment is set up correctly.
- The test equipment can be dismantled.
- After the test, the fitting must be dried as quickly as possible in warm air (Recommended: 45 - 5°C, approx. 30 min in the case of air flow, up to 2 h in the case of stationary air, depending on the device).

9.2.3 Test results

After 5 minutes, either in a coupled or uncoupled state at 700 bar, the pressure drop should only be 5%.

If the test pressure exceeds 700 bar there should only be a pressure drop of 3%. If the pressure drop is larger or if medium emerges, the valve can be considered as leaking and must not be used. Troubleshooting, rectification and a new test should take place.

9.3 Documentation

Tests must be documented with entries for the results, test set up, test pressure, test medium, name/ date and signature.

10 Lubrication

In order to minimise the activation forces and to extend the lifetime of the quick coupling system, we recommend cleaning and lightly greasing the connecting surfaces at suitable intervals as long as there is no risk that contamination in the vicinity will cause increased wear in combination with grease.

Lubrication is not carried out if the application does not permit it (e.g. in medical technology).

The selection of the lubrication is determined by the operator of the quick coupling systems and the purchasing options.

The connecting surfaces may only be lubricated if the operating conditions permit it.

Thus:

- The lubrication must be selected in accordance with compatibility with the seal quality and material.
- Media/lubrication combinations in which the lubrication properties are changed (e.g. turns to resin) must be avoided.
- Media/lubrication combinations that prevent safe operating conditions (e.g. lubrication/oxygen) must be avoided.

The lubrication interval depends on the framework conditions and the use of the application and is determined by the operator.

11 Storage

The fast coupling system must be stored in such a way that no damage can occur.

To avoid damages or contamination, transportation caps must be applied to all connections.

The storage conditions of the fast coupling element must be in line with the guidelines for seals since here incorrect storage may cause changes.

The following points are to be observed:

- The seals must be stored dry.
- For safe maintenance of seals, seals should not be stored under the influence of daylight.
- To protect against oxygen, the seals should be stored in the packaging.

12 Decommissioning

At the end of the life cycle, the quick coupling system, or the individual components thereof, must be disposed of in an environmentally friendly way, according to the legal requirements.

Local public or private waste disposal companies should be used for this.

13 Contact data

WALTHER-PRÄZISION

Carl Kurt Walther GmbH &Co. KG

Westfalenstrasse 2

42781 Haan

Postfach 42 04 44

42404 Haan, Germany

Tel.: +49 (0) 2129 / 567-0

Fax: +49 (0) 2129 / 567-450

Email: info@walther-precision.de

Internet: www.walther-precision.de

Contact partner:

Application technology and service

Holger R. Figge

Telephone: +49 (0) 2129 / 567-591

Fax: +49 (0) 2129 / 567-590

Mobile: +49 (0) 162 / 5672090100

Email: hfigge@walther-precision.de

Any replication, evaluation or communication to unauthorised parties is thus actionable and will be pursued in court (copyright law, fair trade law, BGB - German Civil Code).

All rights reserved for the event of patent grant (paragraph 7, section 1 German Patent Law) or registration of a utility model or design (paragraph 5, section 4 German Utility Model Law)

The copying of documents by clients of WALTHER-PRÄZISION is only permitted for internal company use

WALTHER-PRÄZISION thanks you for your trust in selecting a product from our range.